

SK007-120cm
5-1②

Design & pattern
ORIKI
5cm×5cm

縫い代 2cm

縫い代 1cm

②と貼りあわせる



左ファスナー
あきどまり



Design & pattern
ORIKAI

SK007-120cm
前パンツ 5-1①

2枚

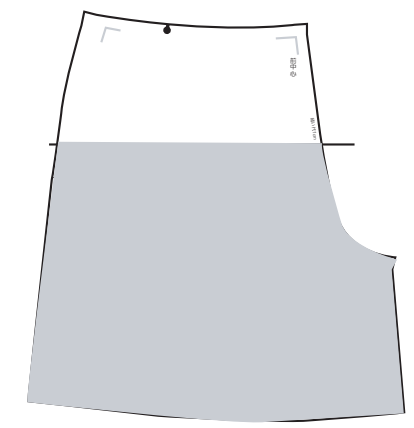

縫い代 1cm

SK007-120cm
5-1①

Design & pattern
ORIKAI

5cm×5cm

縫い代 2.5cm

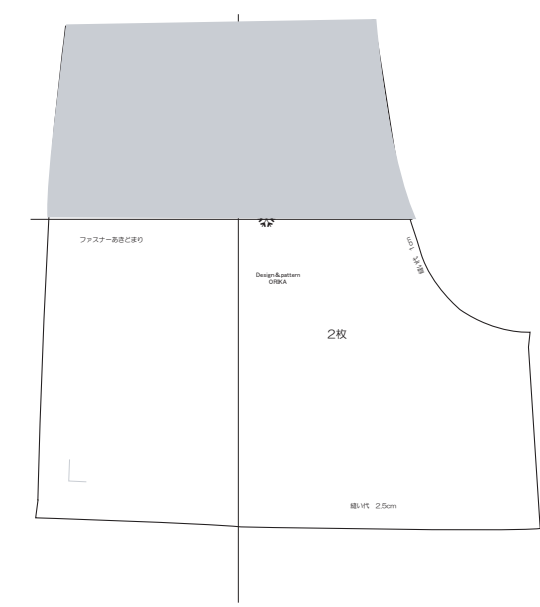
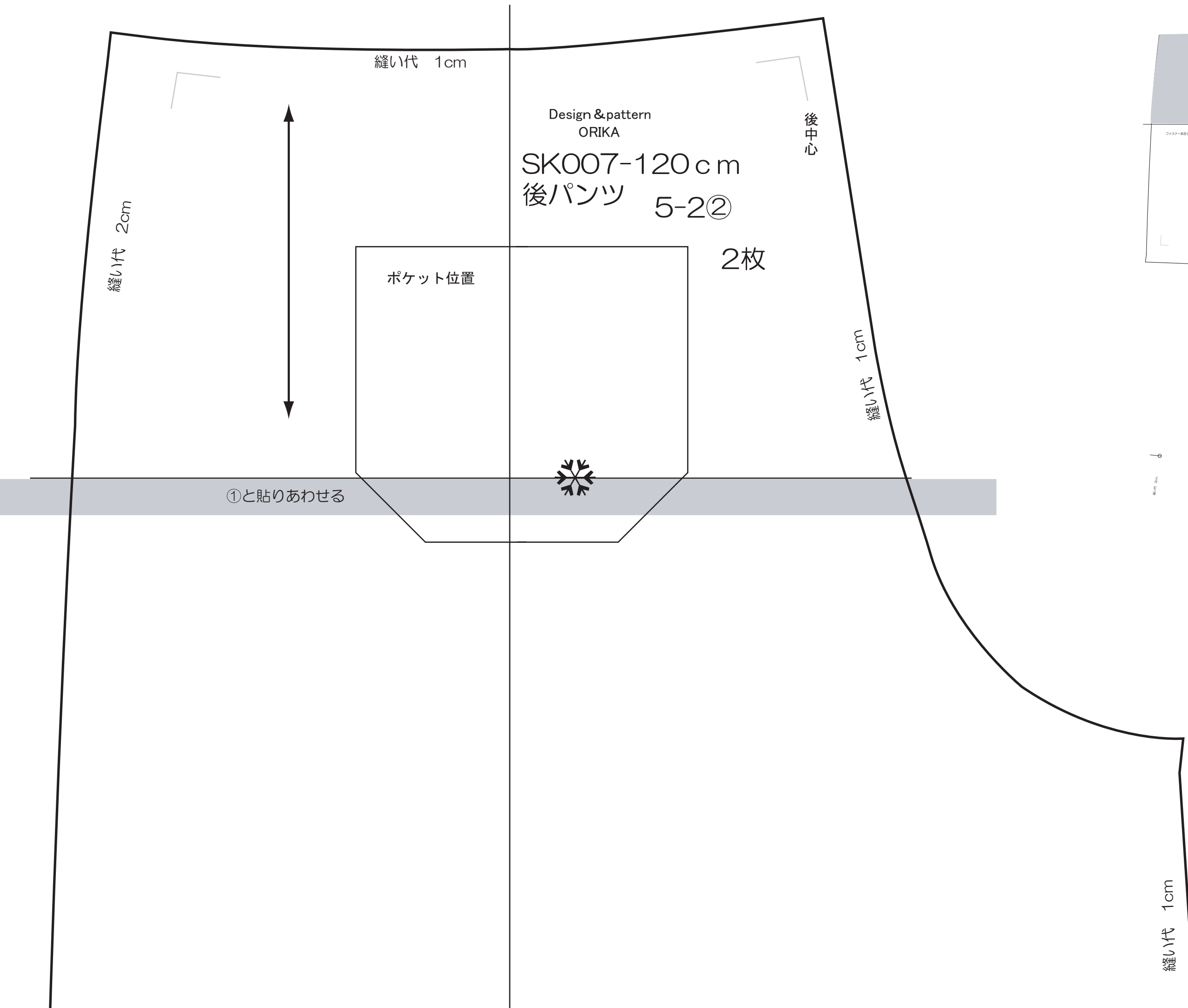

SK007-120cm
5-2②

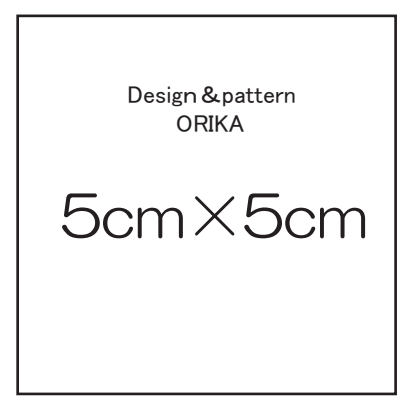

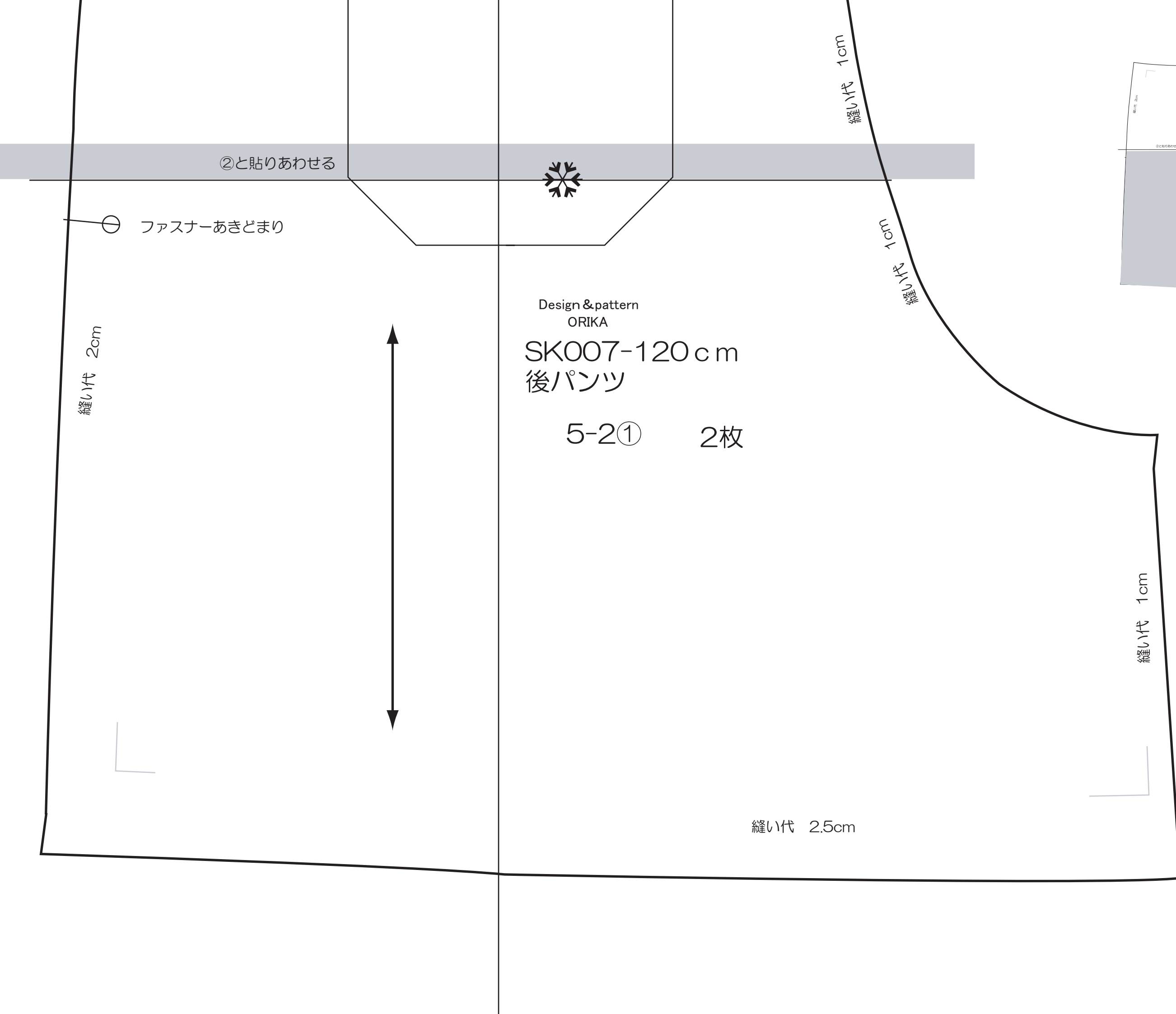

②と貼りあわせる

⊕ ファスナーあきどまり

縫い代 2cm

縫い代 1cm

縫い代 1cm

Design & pattern
ORIKA
SK007-120cm
後パンツ

5-2① 2枚

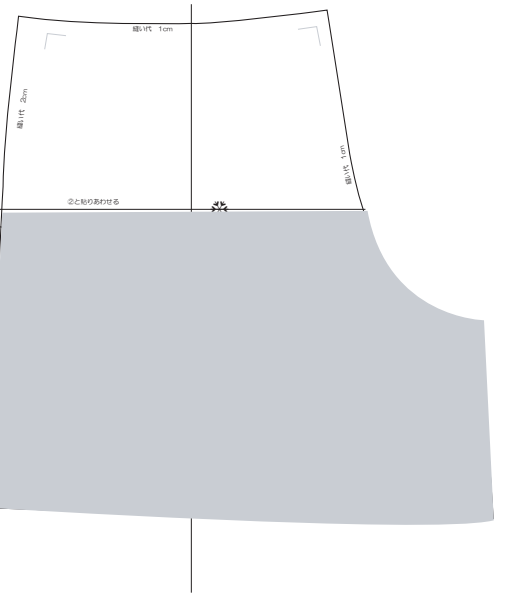

SK007-120cm
5-2①



縫い代 1cm

縫い代 2.5cm

右脇側

縫い代 2cm

縫い代 1cm

縫い代 1.5cm

前中心

Design & pattern
ORIKI

SK007-120cm
前ラップ布 5-3②

1枚

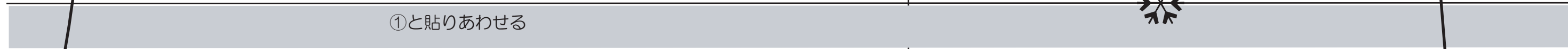

①と貼りあわせる

SK007-120cm
5-3②

Design & pattern
ORIKI

5cm X 5cm

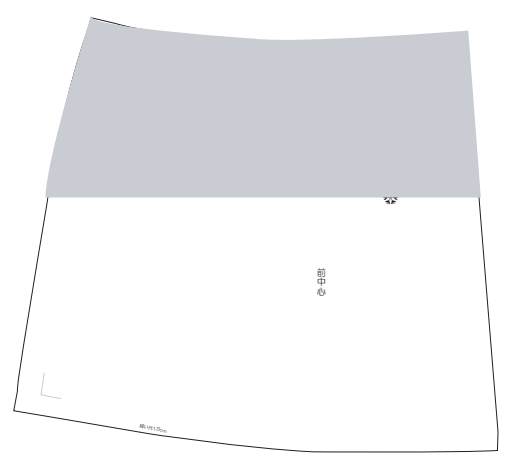

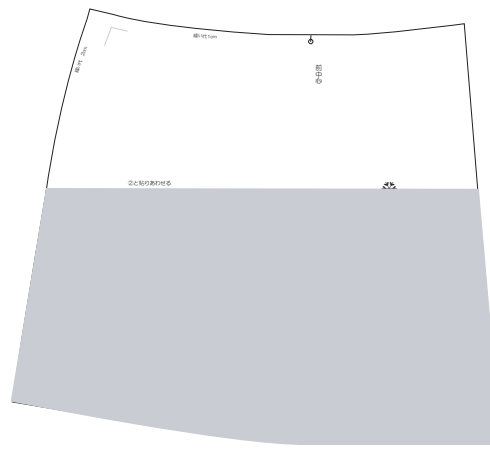

Design & pattern
ORIKAI

SK007-120cr
5-3①

Design & pattern
ORIKAI

5cm X 5cm

②と貼りあわせる



右脇側

Design & pattern
ORIKAI

SK007-120cm
前ラップ布 5-3①

1枚

前
中
心

縫い代1.5cm

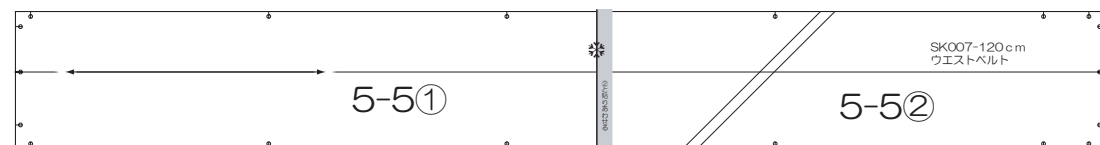
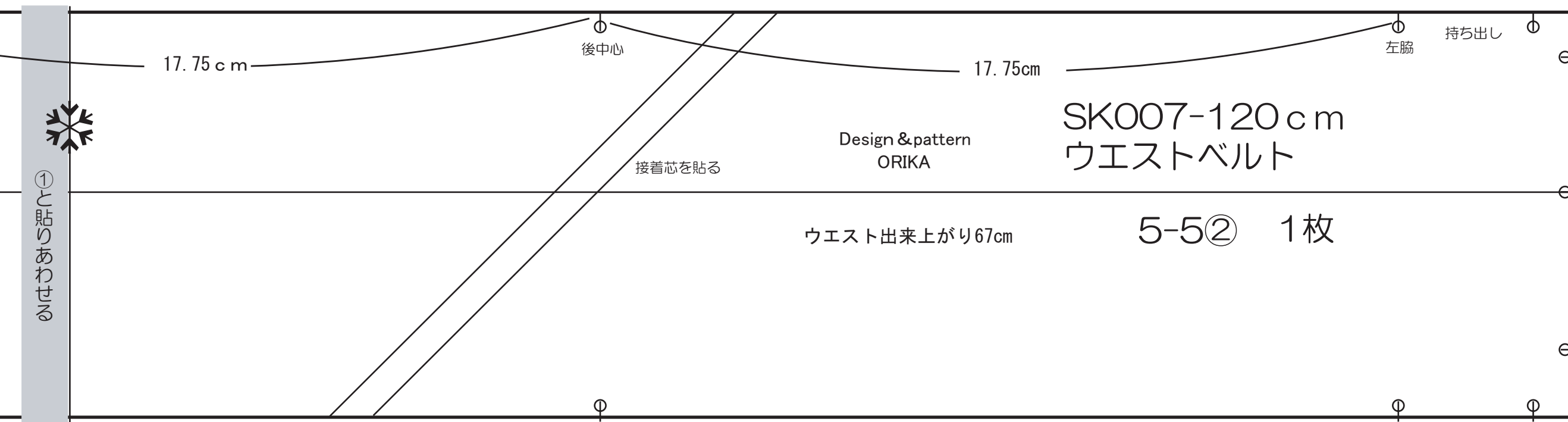
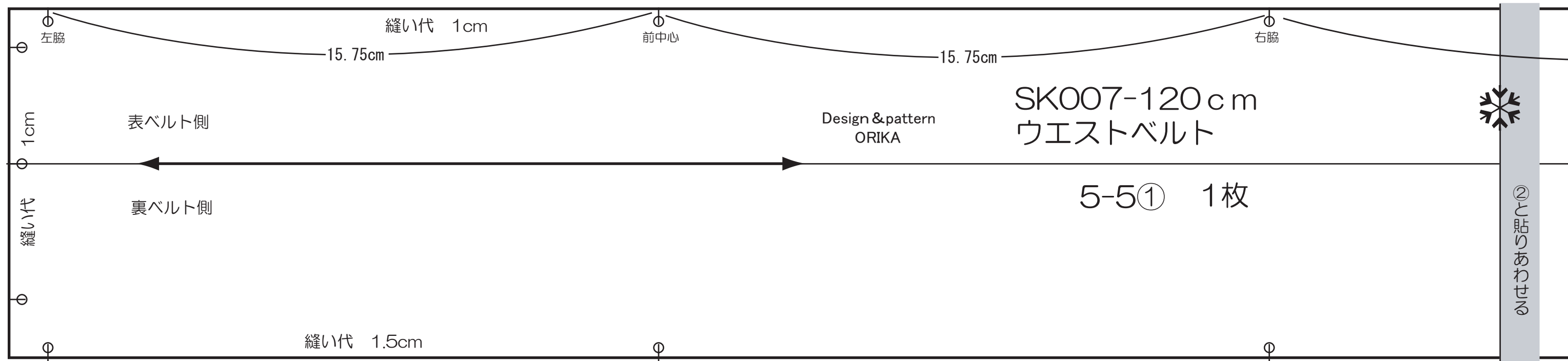

SK007-120cm
5-5

Design & pattern
ORIKA
5cm×5cm

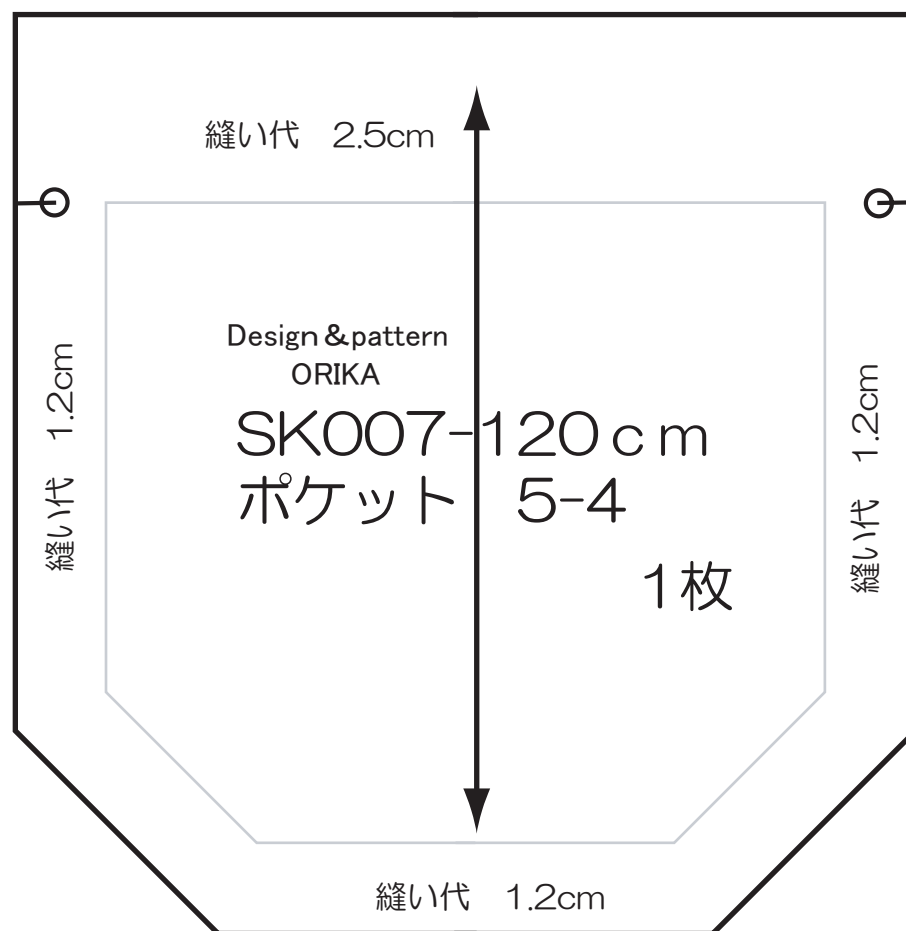

SK007-120cm
5-4

